

Data Sheet



Article number: 021500700082

Description: Sealing Clamp S 82 W5

Measures

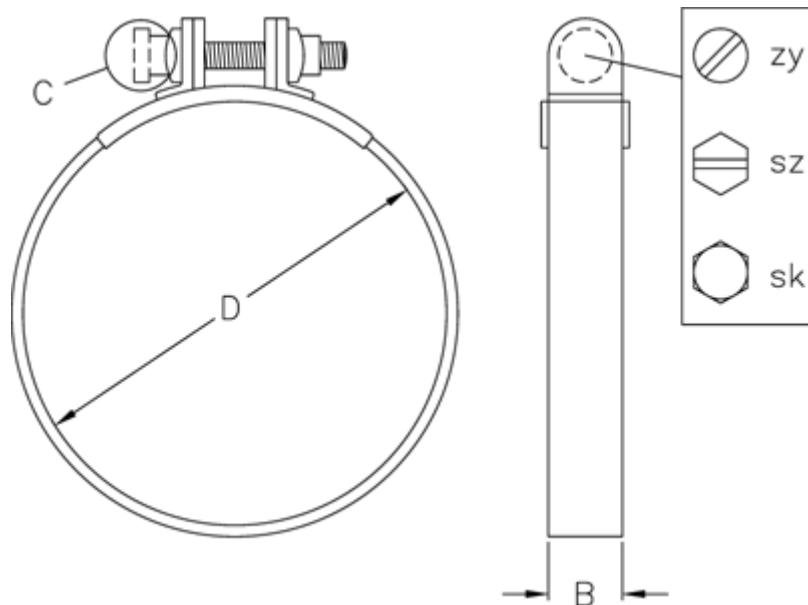

C (screw type) = SZ

Diameter D = 82

Width B = 20